

Data Sheet



Article number: 025799300118

Description: Norma Connect pipe coupling
GRIP E W5 Ø=118,0 EPDM, 16 bar

Measures

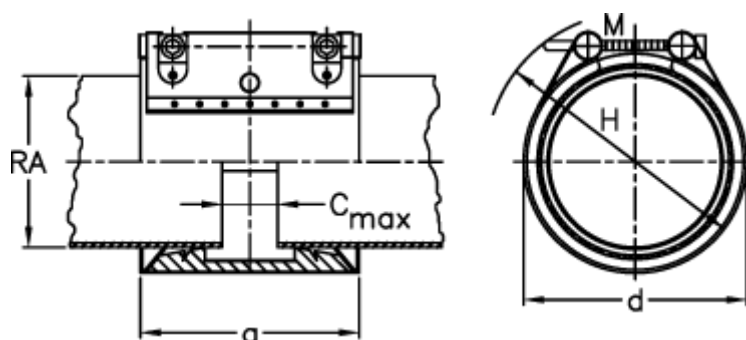

a	= 98
C max with insertion band	= 25
d	= 135
H	= 155
M (screw)	= M10
Nominal pressure (bar)	= 16
RA	= 114.3
RA min-RA max	= 112,0-115,4

Weight a piece = 1.8